

nexusTM

200 / 300 Eazy Retro Upgrade Kit

Installation and instruction manual for:

Type 2 - Nexus 200 and 300 Upgrade Kit

(Upgrades the Eazy Filter in a Nexus 200 and 300 Models Manufactured Between 2006 - 2009 to the Nexus 210 and Nexus 310)



Which type of Nexus do you have?

Nexus 200 / 300 Manufactured before 2006

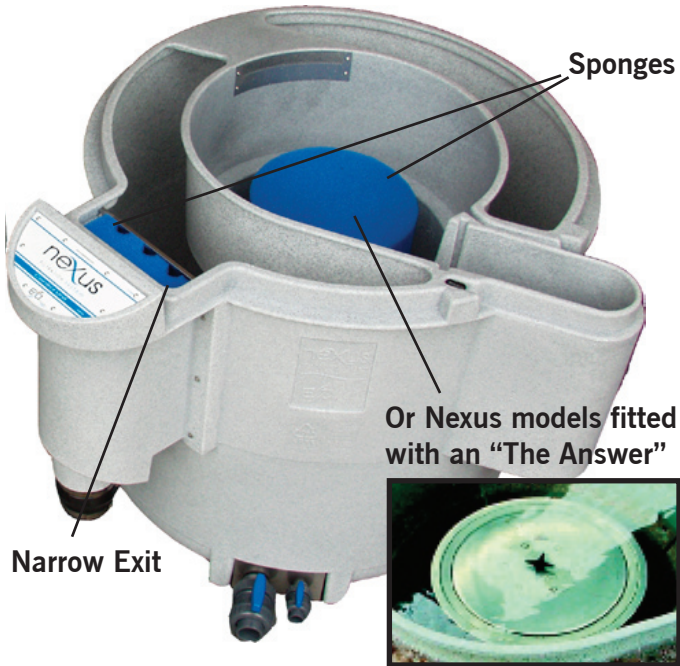

Nexus 200 / 300
Manufactured before 2006
Without an Eazy Filter

If you have this type of Nexus filter you are able to upgrade the inner chamber to allow you to install the Eazy filter.

You will need:

Type 1 - Nexus Upgrade Kit (Eazy Retro Kit)

Additionally, you can install an overflow / by-pass kit on this model of Nexus 200 or 300.

For this you will need:

Type 1 - Nexus Overflow / Universal By-Pass Kit

Nexus 200 / 300 Manufactured 2006 to 2009

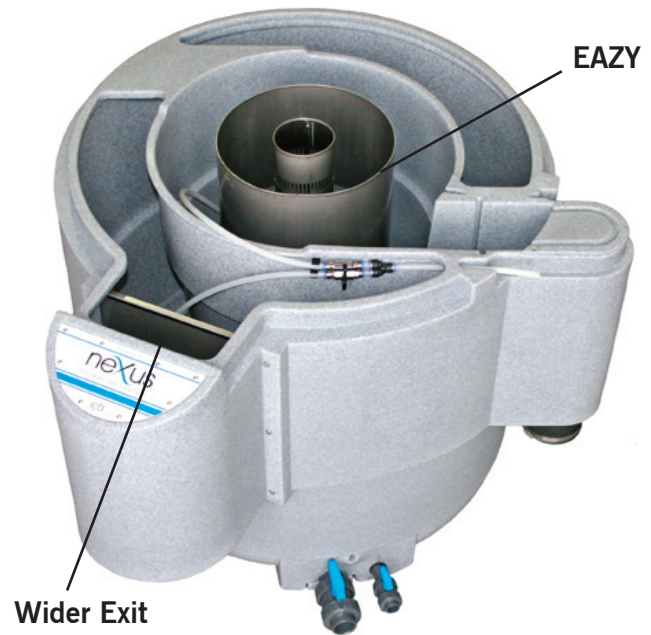

Nexus 200 / 300
Manufactured between 2006 and 2009
With a Pre-2009 Eazy Filter

If you have this type of Nexus filters you are able to upgrade the Eazy Filter to a Post 2009 Eazy filter as used in the Nexus 210 or 310.

To do this you will need:

Type 2 - Nexus Eazy Upgrade Kit

Additionally, you can install an overflow / by-pass kit on this model of Nexus to give you all the benefits of a Nexus 210 and Nexus 310.

To do this you need:

Type 2 - Nexus Overflow / Universal By-Pass Kit

NEXUS EAZY UPGRADE KITS

IMPORTANT PLEASE READ BEFORE CONTINUING WITH INSTALLATION

This manual will give you all the information needed to upgrade your existing Nexus 200 or 300 to a Nexus 210 or 310. First step is to establish which of the two methods of installation you intend to use. Your Nexus units could be installed in the following configurations:-

ARE YOU PUMP FED? By this we mean that if your pump is going to be used to supply the water to the filter, and the filtered water then returns back into your pond via gravity, i.e. down a waterfall, or through a large diameter pipe, this is referred to as PUMP FED (i.e. the water is fed to the filter using a pump).

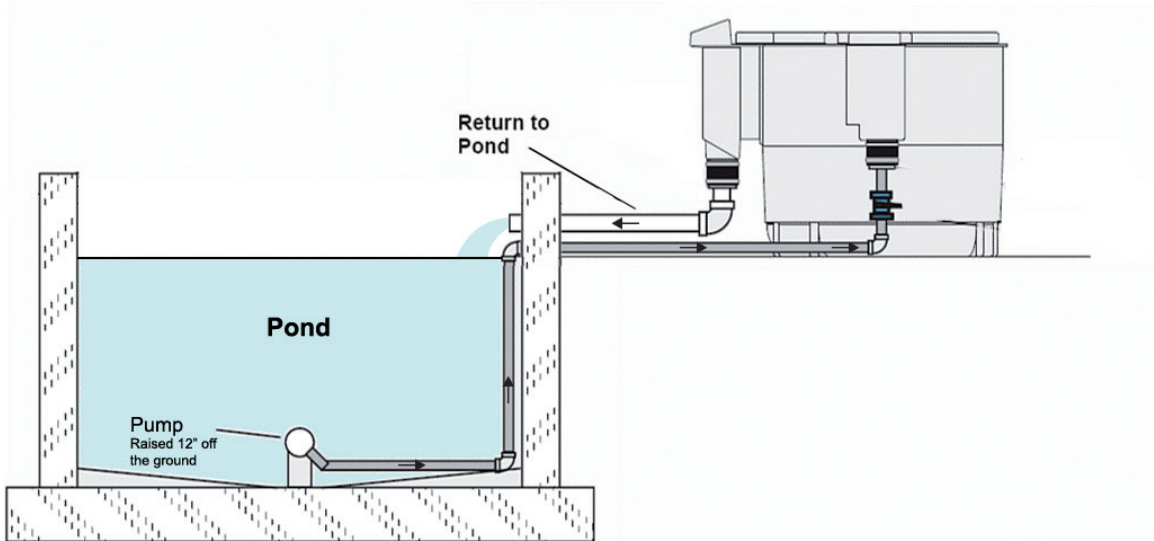

ARE YOU GRAVITY FED? By this we mean that your pump is going to be used to return the filtered water to the pond and therefore your filter will be supplied by gravity via a larger diameter pipe. In this situation the water level in the filter will be at the same level as the pond.

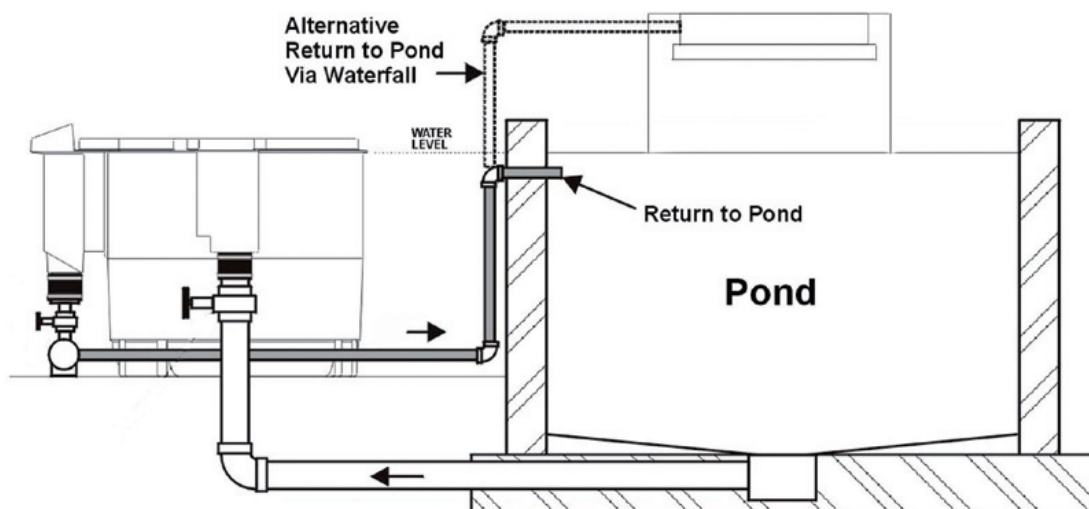

ENSURE THAT ONCE YOU HAVE ESTABLISHED WHICH SET UP YOU WANT TO USE, REFER ONLY TO THE CORRECT SECTION IN THIS MANUAL.

Your Nexus TYPE 2 Upgrade Kit parts checklist:-

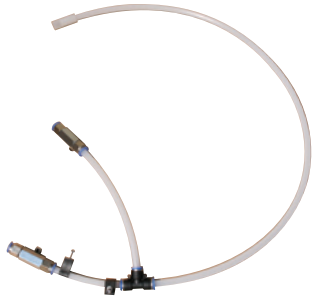

Air hose



Bag containing jubilee clips and screws



Inner centre column complete with flap



Eazy Main Body including Air Ring



Nexus 200 Upgrade Kit Only

Screwdriver, Silicone sleeve & Screw



Eazy Centre Lid

You may also need a tube of Aquarium Silicone (not included).

Please Note: When upgrading from a **pump fed** Nexus 300 to a pump fed Nexus 310 you may need to lower the outlet pipe by approximately **20mm**.

NEXUS 200 / 300 EAZY UPGRADE KIT INSTALLATION

1. Empty your Nexus and remove the K1 and place to one side ready to re-use.

2. Remove the airline and the Eazy filter from inside your Nexus as in figures 1 to 4. Undo airline to biological stage (leave in place).

FIG.
1



FIG.
2



FIG.
3



FIG.
4



3 Place the circular Eazy Main Body into position with the plate directly over the waste outlet. Notice the position of the hole on the Eazy Main Body for the airline to go through. (Figure 5)



4 When positioning the Eazy Main Body air-ring, the T piece connector needs to be opposite this hole.

5 Attach the 3 black hose clips onto the air ring, spacing them equally. Place the ring in position over the centre column of the Nexus.

6 Mark the position of the clips. Remove the ring, and screw the clips into the positions that you marked using the self tapping screws provided. (Figure 6)



7 Place the Eazy Main Body into position with the plate over the waste outlet, install the air ring and connect up the air line.

8 Screw the Eazy Main Body into position by using the self tapping screws provided through the tabs on the bottom of the Eazy. N.B. On a Nexus 200 the tabs are on the outside (Fig. 7), on the 300 the tabs are on the inside (Fig.8). Please ensure that when screwing the 200 Eazy Main Body down, that the steel work is positioned in the groove, making sure that the K1 media cannot escape.

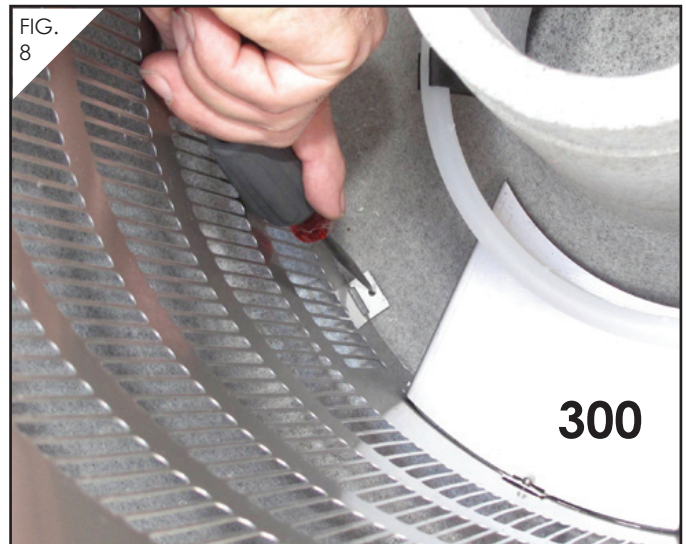

8 Install the inner centre column by placing it over the centre column of the Nexus and tighten the jubilee clip provided. It is recommended that you run a bead of aquarium silicone around the inside bottom edge of the stainless steel centre piece to enable a watertight seal.

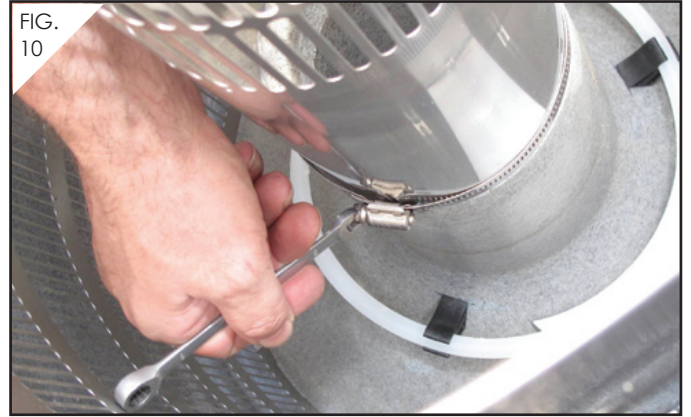

9 Replace the K1 into the Eazy. Fill up to the level shown ensuring that the top grill on the Eazy Main Body is still visible. Now clip on the clear lid.

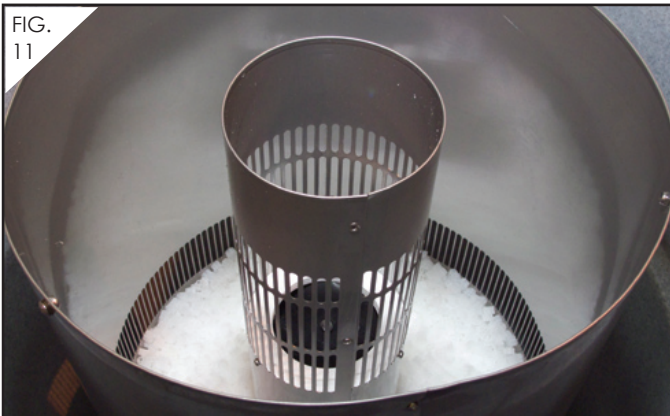

10 Ensure the airline is connected. Fix airline to the filter using the clips provided as shown.

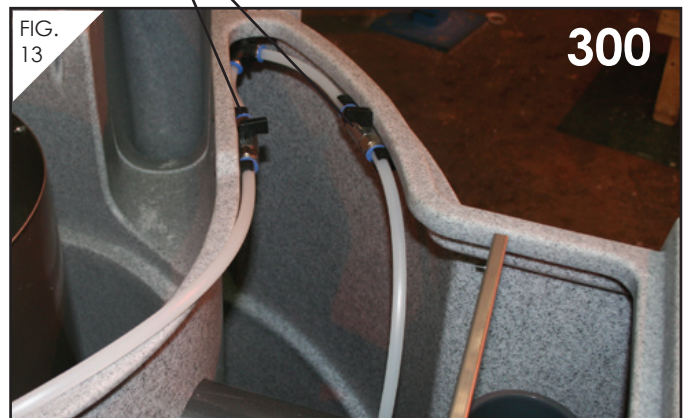
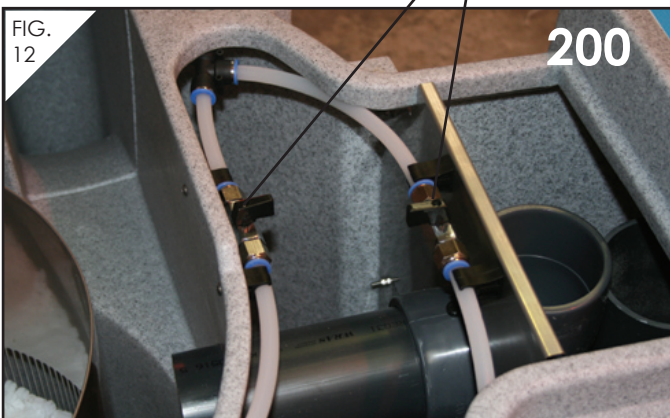



NEXUS 210 / 310 UPGRADE KIT INSTALLATION

EVOLUTION
AQUA

NEXUS CLEANING INSTRUCTIONS - PUMP FED



Fig 3.1 Normal operation



Fig 3.2 Needs cleaning

CLEANING YOUR NEXUS PUMP FED

The central 'Eazy' section of the Nexus will collect all the debris and suspended solids that come into the filter. In time you will find out how often you need to clean this, and probably get into a routine to keep the filter working at its optimum. Each pond is different, and the regularity of cleaning is affected by stocking levels and feeding rates along with other factors such as algae in the pond.

WHEN TO CLEAN?. The indication that your filter requires cleaning is when you see water flowing out of the overflow as in Fig 3.2. Normally we would not recommend leaving the filter uncleaned more than 3 weeks. The filter can be left longer if absolutely necessary but this would not be best practice.



Fig 3.3

Cleaning procedure

1. Close the valve at the Nexus inlet and immediately switch off your pump.
2. Close the inlet to the inner chamber by inserting inlet slide-plate supplied with your Nexus. Your Eazy is now isolated from the rest of the system
3. Turn the air valve to divert the air into the Eazy, close the air valve to the bio stage.
4. The K1 media in the Eazy will now be agitated vigorously, or 'boil'. As this happens, all the debris trapped in the K1 will be released into the vortex area of the central chamber.
5. After about 5 minutes, open the waste valve, allowing the waste to drain out with the water Fig 3.3.
6. Take out the inlet slide plate.
7. Open the valve on the inlet, switch on your circulating pump.
8. Close the waste valve.
9. Close the air valve, to the inner chamber and open the air valve to the outer chamber.
10. We would recommend that you perform the cleaning process twice wherever possible to ensure best results.

NEXUS CLEANING INSTRUCTIONS - GRAVITY FED

CLEANING YOUR NEXUS GRAVITY FED

The central 'Eazy' section of the Nexus will collect all the debris and suspended solids that come into the filter. In time you will find out how often you need to clean this, and probably get into a routine to keep the filter working at its optimum. Each pond is different, and the regularity of cleaning is affected by stocking levels and feeding rates along with other factors such as algae in the pond.

WHEN TO CLEAN? You may also notice that the water level in the outer chamber – the Biological stage – lowers as water is prevented from getting through the Eazy as quickly as it is being pumped back into the pond. When this water level falls beneath the level of the bypass pipe, this is the indication that you should clean the Eazy. Normally we would not recommend leaving the filter uncleaned more than 3 weeks. The filter can be left longer if absolutely necessary but this would not be best practice.

Cleaning procedure

1. Switch off your circulation pump.
2. Close the inlet to the Nexus by inserting inlet slide-plate supplied with your Nexus. Your Eazy is now isolated from the rest of the system
3. Turn the air valve to divert the air into the Eazy, close the air valve to the bio stage.
4. The K1 media in the Eazy will now be agitated vigorously, or 'boil'. As this happens, all the debris trapped in the K1 will be released into the vortex area of the central chamber.
5. After about 5 minutes, open the waste valve, allowing the waste to drain out with the water.
6. Close the waste valve.
7. Take out the slide plate
8. We would recommend that you perform the cleaning process twice wherever possible to ensure best results.
9. Close the air valve, to the inner chamber and open the air valve to the outer chamber.
10. Switch on your circulation pump.

LONGER PERIOD OF TIME BETWEEN CLEANING

Regular cleaning of the Eazy is essential to maintain your pond at its best. Build up of detritus in any pond filter can harbour pathogens, and other pollutants which may harm your fish. At times, you may want to leave your filter for longer than you would normally want between cleaning, perhaps if you go on holiday. In these instances, your Nexus incorporates a Bypass, which will prevent the bio stage from emptying, and therefore potentially starving your pump of water, should your Eazy become full of debris. The filter bypass should be turned 90 degree as per figs. 7.1-7.3, when you need to leave your filter for longer periods of time such as holidays etc. this will allow the water to bypass the eazy should it become blocked. On return from your holidays - turn the bypass back to 12.00 o'clock see Fig 7.1. Normally we would not recommend leaving the filter uncleaned more than 3 weeks. The filter can be left longer if absolutely necessary but this would not be best practice.



Fig 7.1



Fig 7.2



Fig 7.3

HOW TO GET THE BEST FROM YOUR NEXUS FILTER

PURE POND

Take a look of our new Pure Pond bacteria gel balls. With over 8 billion bacteria per Litre of Pure Pond Balls, your pond will shine, especially if you add them monthly into the Kaldnes Moving bed. The Pure Pond balls are made from a biodegradable polymer, and crammed full of bacteria that are slowly released when they are needed most. When you introduce the Pure Pond balls into the biological chamber of your Nexus, they become one with moving bed, agitating alongside the K1 media, just waiting to smooth out the peaks and troughs of the Ammonia/Nitrite cycle.

Getting the most from your Nexus has never been easier. Contact your Nexus dealer to find out more.



Pure Pond bio balls.

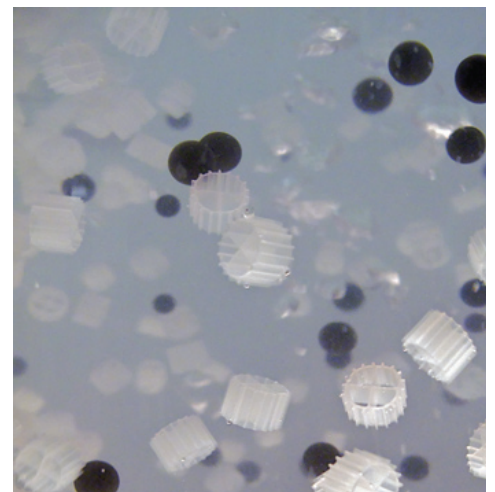

Pure Pond bacteria gel balls in the Kaldnes moving bed filter.