

SURGE11002241MAN

UK / EU / USA
English

EVOLUTION
AQUA

INNOVATION IN WATER

surge

Innovative Pond Filter with UVC

INSTRUCTION MANUAL

IMPORTANT:

WARNING: Never look directly at an illuminated UV bulb.

Ensure the o-rings provided are fitted to the ball valves and hosedetails.

Read the instructions carefully before carrying out the installation.

IMPORTANT SAFETY INSTRUCTIONS



- READ AND FOLLOW ALL INSTRUCTIONS

- **WARNING** - (UK / EU MODELS) A Residual Current Device (RCD), also known as the Residual Current Circuit Breaker (RCCB), with a tripping current not exceeding 30mA must be installed in the supply circuit. A means of disconnection from the supply having a contact separation of at least 3mm in all poles must be incorporated in the wiring.
- **WARNING** - (USA MODELS) Risk of Electric Shock. Connect only to a branch circuit protected by a ground-fault circuit interrupter (GFCI). Contact a qualified electrician if you cannot verify that the circuit is protected by a GFCI.
- **WARNING** - If the supply cord is damaged, it must be replaced by the manufacturer, its service agent or similarly qualified persons in order to avoid a hazard.
- **WARNING** - To reduce the risk of electric shock, do not use extension cord to connect unit to electric supply; provide a properly located outlet.
- **WARNING** - Do not operate the UV-C emitter when it is removed from the appliance enclosure.
- Unintended use of the appliance or damage to the housing may result in the escape of dangerous UV-C radiation. UV-C radiation may, even in little doses, cause harm to the eyes and skin. Never look directly at an illuminated UV bulb.
- Do not leave the UVC switched on for prolonged periods when the filter has no water inside.
- Always disconnect all pond appliances from the mains supply before putting your hands into the water.
- Use in the area only if the installation complies with the relevant wiring regulations.
- This unit must be earthed when earth wire is fitted.
- Never use a fuse larger than 3 amps on the power lead.
- The unit must not be submerged in water.
- If the quartz sleeve is cracked, replace it immediately.
- Filter should be run consistently and lagged with frost protection in winter.
- Children shall not play with the appliance. Cleaning and user maintenance shall not be made by children without supervision.
- **WARNING** - Disconnect the appliance from the supply before carrying out maintenance.
- Max. operating temperature of UVC ballast 35°C.
- Max pressure 0.3 bar.
- DO NOT put the UVC ballast in direct sunlight.

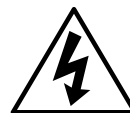
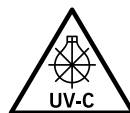

SAVE THESE INSTRUCTIONS

EPA Est. No. 100154-GBR-1

ABOUT THE SURGE FILTER

The Surge Filter is an innovative filter that will help to deliver crystal clear, healthy water for ponds up to 5,000 Litres (1,100 Gallons / 1,320 US Gallons). The Surge Filter uses K+Media for enhanced mechanical and biological filtration to trap fine particles and to help maintain a biological equilibrium within the pond. In addition, an 18 Watt UV Clarifier (UVC) is integrated into the top of the filter to help prevent green water.

The Surge Filter is easy to install and is simple and quick to clean, using Evolution Aqua's patented Air Clean Technology. This unique air syphon design allows air to be drawn into the filter as it empties which causes the water to agitate, effectively cleaning the K+Media. There are no dirty sponges or foams to clean so you get to keep your hands dry, giving you more time to enjoy your pond.



SCAN QR CODE
To Learn More

SURGE FILTER PARTS



Surge Filter pre-filled with 4.5 litres of K+Media



UVC - 18W PL-L UV-C bulb, quartz sleeve, ballast and cable



Qty x 2 - 1" ball valves and o-rings



Qty x 1 - 1" black threaded hose tail and o-ring (INLET)



Qty x 1 - 1" clear hose tail and o-ring (OUTLET)



Waste valve assembly



Qty x 2 - Mounting brackets

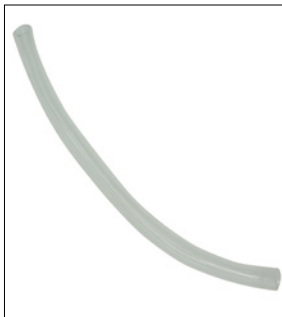

500mm (19.7") length of 1" (25mm) clear PVC hose (WASTE)



Qty x 1 - Threaded elbow and flat washer (WASTE)

ALSO REQUIRED:

Evolution Aqua flexible PVC hose and hoseclips ($\frac{3}{4}$ ", 1", 1 $\frac{1}{4}$ " - UK / USA) (20mm, 25mm, 32mm - EU)

Submersible pond pump (Capable of delivering 3,500 lph / 770 gph / 925 US gph or less)

Tools and fixings (To securely fix mounting brackets to wall or post)

SURGE FILTER OVERVIEW

BRACKET

Top mounting bracket

18W UVC

Ballast and 18W PL-L UV-C bulb

K+MEDIA

4.5 Litres

WASTE VALVE ASSEMBLY

Including Air Clean Technology valve

BRACKET

Bottom mounting bracket

SIGHT GLASS

Water flow and UV light indicator when hose is connected

OUTLET

Ball valve with clear threaded hosedetail. Connect to flexible PVC hose for return to pond

INLET

Ball valve with threaded hosedetail. Connect to flexible PVC hose and a submersible pond pump

CLEAR DRAIN HOSE

500mm clear hose to help drain waste water



SURGE FILTER SPECIFICATIONS

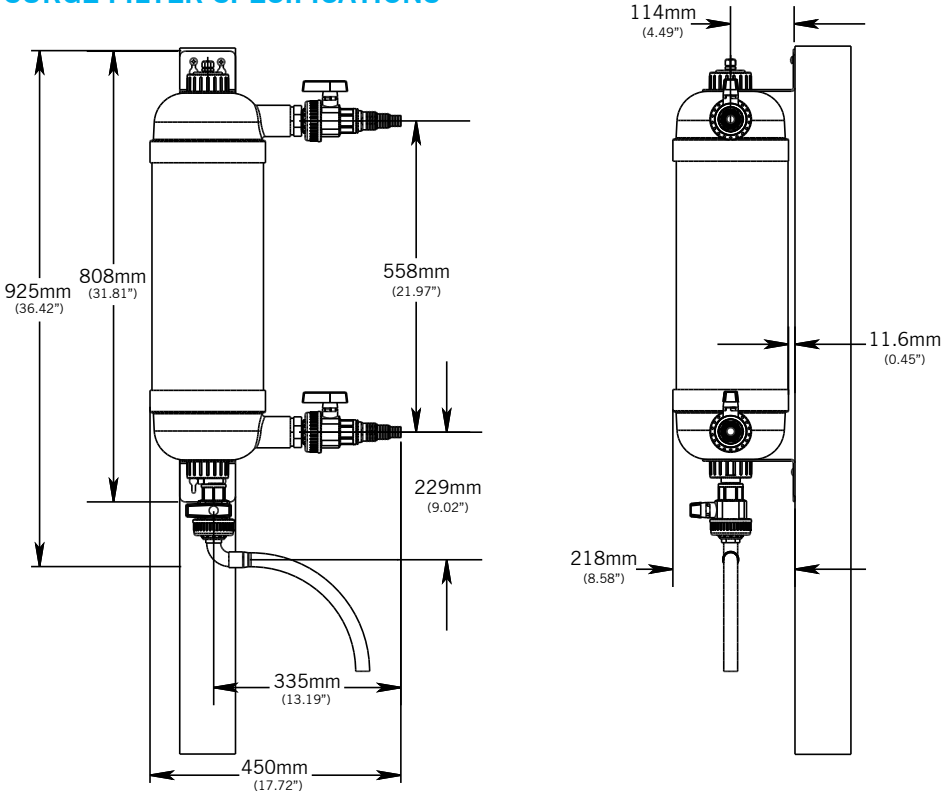

MAXIMUM POND SIZE	5,000 Litres / 1,100 Gallons / 1,320 US Gallons
INLET	3/4", 1", 1 1/4" (UK / USA) / 20mm, 25mm, 32mm (EU)
OUTLET	3/4", 1", 1 1/4" (UK / USA) / 20mm, 25mm, 32mm (EU)
WASTE	1" (UK / USA) / 25mm (EU)
MAXIMUM FLOW RATE	3,500 lph / 770 gph / 925 US gph
OPTIMUM FLOW RATE	2,500 lph / 550 gph / 660 US gph
K+MEDIA SUPPLIED	4.5 Litres / 0.99 Gallons / 1.19 US gallons
WATER VOLUME IN FILTER	19 Litres / 4.2 Gallons / 5 US Gallons

SURGE FILTER INSTALLATION

The Surge Filter is designed to be used on **PUMP-FED** installations, where a submersible pump is located in the pond sending water from the pond, through the Surge Filter and allowing it to return to the pond by gravity.

TIP: The pond return can be made decorative by connecting it to a waterfall or watercourse for example.

For the filter to be most effective, we recommend an optimum flow rate running through the filter of **2,500 litres per hour** (550 gph / 660 US gph). Do not exceed the maximum flow rate of **3,500 litres per hour** (770 gph / 925 US gph).

Ensure you have enough length of flexible hose to connect the pump to the filter and from the filter back to the pond. It is recommended to use Evolution Aqua 32mm (1 1/4") flexible hose, available from Evolution Aqua stockists.

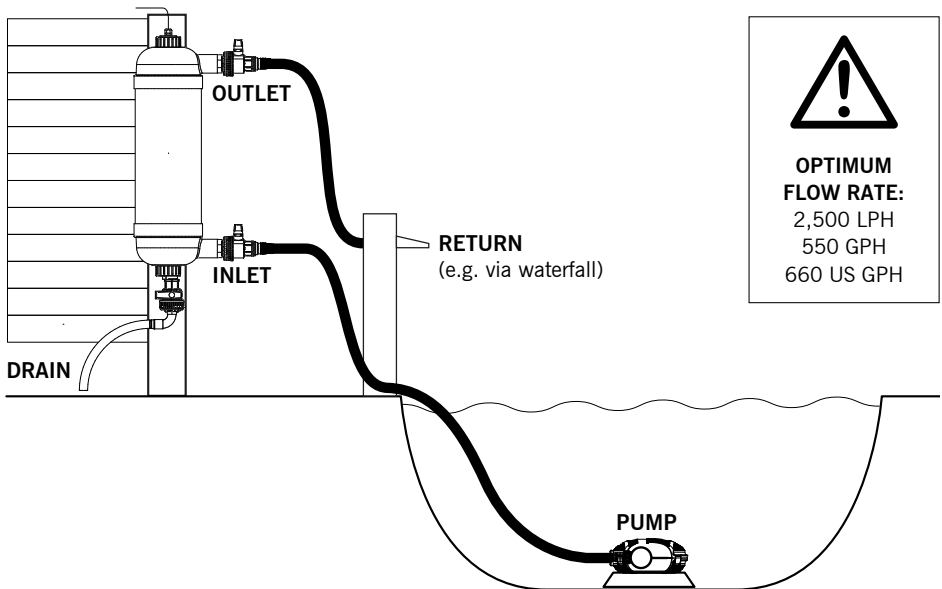

TIP: Slightly raise the pond pump off the bottom of the pond.

The Surge Filter can also be installed alongside raised ponds.

MOUNTING THE SURGE FILTER



PLEASE NOTE the filter will weigh approximately 25kg when filled with water so ensure your fixing points can take the weight.

The Surge Filter can be mounted to a wall, wooden frame or timber post using the stainless steel mounting brackets provided.

IMPORTANT: Source suitable screws and fixings to fit the mounting brackets to enable the filter to be securely mounted.

The Surge Filter can **ONLY** be installed vertically with the waste valve assembly at the bottom of the filter. You can choose to have the ball valves facing the left or right, depending on your set-up.

Always ensure there is space around the filter to allow for maintenance, for example to remove the UV bulb, fit the waste hose etc.

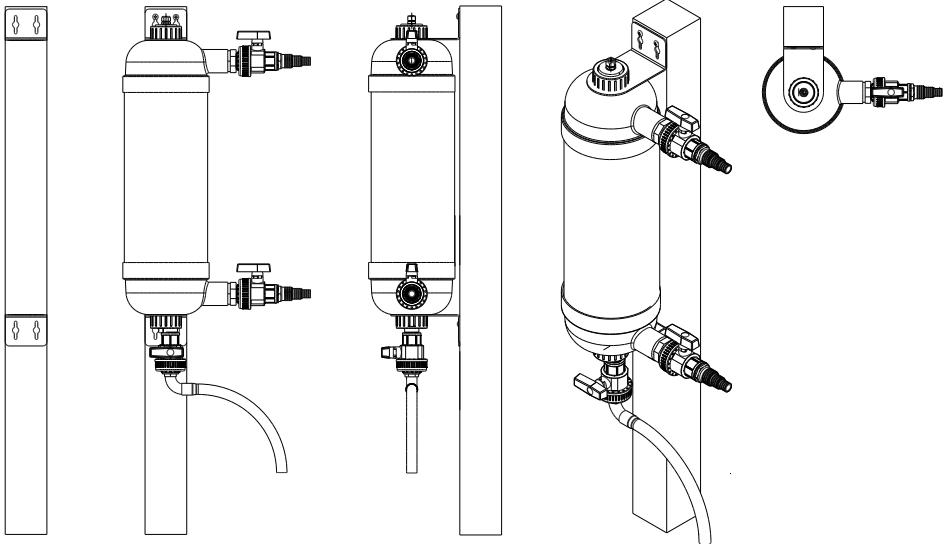
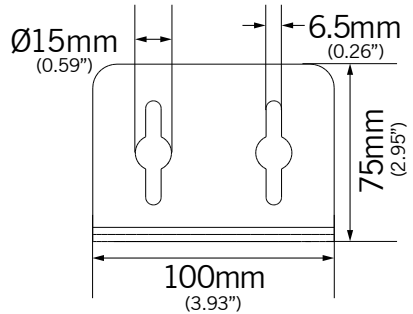
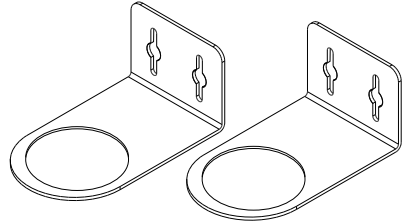

INSTALLING THE SURGE FILTER - MOUNTING



IMPORTANT: Unscrew the UVC bulk head collar, carefully slide out the bulb and store it safely while you install the Surge Filter.



Identify the best location to securely mount your filter to a post, fence or wall and source suitable screws and fixings.



Unscrew the UVC bulk head collar, slide out the bulb and store it safely. The quartz sleeve can be left in place.



Locate the stainless steel mounting brackets. Take one of them to install at the bottom of the filter.



Mark the location of the bracket ensuring the filter is at the appropriate height allowing you easy access to the valves and drain valve.



Use a spirit level to check the bracket is level and tighten up the screws accordingly.



For final positioning, the screws should be located at the top of the cut-outs in the bracket.

TIP: Loosen the screws to move the bracket up and down to remove it.

INSTALLING THE SURGE FILTER - MOUNTING



IMPORTANT: The top bracket must rest on top of the Surge Filter to ensure the UVC collar can be screwed in fully.



Re-fit the Surge Filter with the drain outlet resting on the bottom bracket. Place the other mounting bracket over the top of the filter.



Rest the bracket on top of the filter and mark the location of the bracket ensuring the filter is vertical.



Using a spirit level to check the bracket is level, screw two screws through the bracket to fix it.



Double check all the brackets are level, the top bracket is resting on the filter and tighten up all the screws.



Carefully re-fit the UV bulb and tighten up the black collar - **HAND TIGHTEN ONLY**. The collar must be screwed in fully to activate the built-in safety switch.



TIP: You can secure the UVC ballast to the post or wall if needed.

DO NOT LOCATE THE BALLAST IN DIRECT SUNLIGHT.

INSTALLING THE SURGE FILTER - WASTE VALVE ASSEMBLY



Fit the flat washer to the threaded elbow and screw into the bottom of the waste valve assembly.



Make sure the o-ring is seated correctly in the waste valve assembly and carefully screw the collar onto the thread. **DO NOT OVERTIGHTEN.**



Ensure the collar is not twisted when screwing it on as this will cause damage to the thread.



You can re-position the elbow by unscrewing the collar underneath the ball valve handle.



Rotate the elbow into the desired position, then re-fit the collar. Screw the collar hand tight only.



The waste valve assembly is now installed.

INSTALLING THE SURGE FILTER - FITTING BALL VALVES



Fit the o-ring onto the top threaded end of the Surge Filter where the outlet ball valve will go.



Screw the ball valve onto the thread. Hand tighten only.

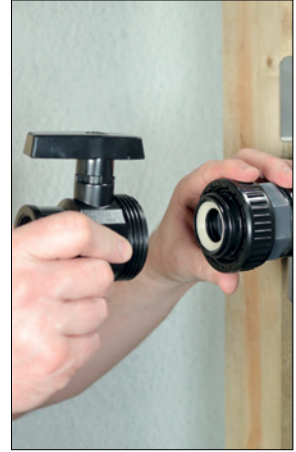

To re-locate the handle, unscrew the ball valve collar, rotate the valve handle in incremental steps to the location needed.



Ensure the components inside the ball valve remain in place, re-fit and tighten the collar up. Hand tighten only.



Repeat the process to install the inlet ball valve at the bottom of the filter. Ensure you fit the o-ring first.



To re-locate the handle, unscrew the ball valve collar, rotate the valve handle in incremental steps to the location needed, and tighten the collar up.

INSTALLING THE SURGE FILTER - FITTING HOSETAILS

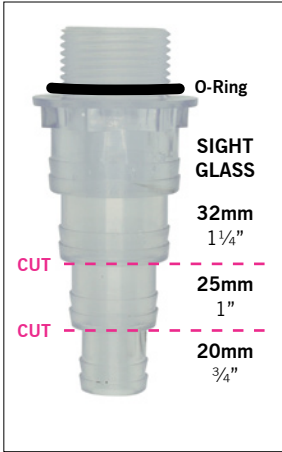

Take the clear hosetail and check which size of flexible hose fits best. We recommend using 32mm hose. Keep the largest step clear to use as a UV light indicator / sight glass.

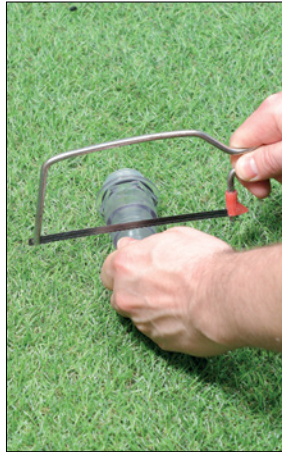

Cut the hosetail down to remove the smaller steps you do not need. This will prevent any restrictions in water flow.



Ensure the black o-ring is on the thread and screw the clear hosetail into the outlet ball valve at the **TOP OF THE FILTER**. **HAND TIGHTEN ONLY.**



Take the black hosetail and check which size of flexible hose fits your hosetail best. We recommend the largest diameter possible (32mm).



Cut the hosetail down to remove the smaller steps you do not need. This will prevent any restrictions in water flow.



Ensure the black o-ring is on the thread and screw the black hosetail into the inlet ball valve at the **BOTTOM OF THE FILTER**. **HAND TIGHTEN ONLY.**

CONNECTING HOSE TO THE SURGE FILTER



The Surge Filter is now ready to connect flexi-hose to the inlet and outlets and to fit the clear drain hose to the elbow at the bottom.



If the hose is difficult to fit you can briefly dip the hose in a cup of hot water to soften it before fitting. **DO NOT USE EXCESSIVE FORCE WHEN FITTING.**



Take the 500mm length of clear hose and push one end of the hose onto the stepped hosetail part of the elbow on the waste valve assembly.



Take a length of flexible hose (max. 32mm) to connect to the clear hosetail to return water to the pond. Use hose clips to secure the hose in place.



Take another length of flexible hose to connect your pond pump to the inlet hosetail on the Surge Filter. Use hose clips to secure it in place.



You are now ready to connect the UVC to the mains electrical supply.

CONNECTING THE UVC TO THE ELECTRICITY SUPPLY

ELECTRICAL INSTALLATIONS MUST BE DONE BY A QUALIFIED ELECTRICIAN

The power supply must meet the specifications on the product. The cores in the supply cable are coloured in accordance with the following code:

UK / EU: Brown = Live. Blue = Neutral. Earth = Green/Yellow

USA: Black = Live. White = Neutral. Green = Earth



The UVC on a EUROPEAN and USA model is fitted with a plug. Not applicable for UK models.

Do not use the cable to lift the UVC as this may cause damage.

WARNING - A Residual Current Device (RCD), also known as the Residual Current Circuit Breaker (RCCB), with a tripping current not exceeding 30mA must be installed in the supply circuit. A means of disconnection from the supply having a contact separation of at least 3mm in all poles must be incorporated in the wiring.



Caution: Use in the area of the garden pond only if the installation complies with the relevant wiring regulations. Please consult a qualified electrician.

Caution: Always disconnect all pond appliances from the mains supply before putting your hands into the water.

All electrical installations and wiring must be adequately protected to prevent any damage.

Enough electrical cable is supplied with the UVC to connect to the mains electric. This unit must be connected to permanent wiring. A switch with 3mm contact separation must be provided in the fixed wiring to provide disconnection from the electricity supply.

WARNING - Never look directly at an illuminated UV bulb.

PLEASE NOTE: The UVC incorporates a safety switch interlock to avoid UV exposure. This means the UV bulb will only illuminate once the bulk head collar has been screwed onto the filter.

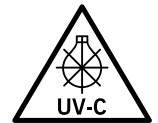

EUROPEAN / USA MODELS EPA Est. No. 100154-GBR-1

For EUROPEAN and USA models the UVC is fitted with a plug. Please follow electrical installation guidance applicable for your specific country before installing the UVC.

GROUNDING INSTRUCTIONS - This appliance must be grounded. In the event of a malfunction or breakdown, grounding will reduce the risk of electric shock by providing a path of least resistance for electric current. This appliance is equipped with a cord having an appliance-grounding conductor and a grounding plug. The plug must be plugged into an appropriate outlet that is installed and grounded in accordance with all local codes and ordinances.

WARNING - Improper connection of the appliance-grounding conductor can result in a risk of electric shock. Check with a qualified electrician or service representative if you are in doubt whether the appliance is properly grounded. Do not modify the plug provided with the appliance; if it will not fit the outlet, have a proper outlet installed by a qualified technician.

OPERATING THE SURGE FILTER

Once you are satisfied that the Surge Filter has been installed correctly, o-rings are fitted, ball valves and fittings are tight, you can turn your pump on to fill it with water.

During normal operation the pump will be switched on, inlet and outlet valves will be open, and the waste valve will be closed. To help clear green water the UVC will be switched on also. Fine particles will be trapped within the K+Media helping to keep the pond water clear and healthy.

During a cleaning cycle, the pump will be switched off, inlet and outlet valves will be closed, and the waste valve will be open. As air enters the filter, the filter media will agitate and any waste particles will dislodge from the media and will flush away as the water drains from the filter to waste.

NOTE: The UVC can be left switched on during cleaning cycles. However, for prolonged periods of time when the filter is empty of water we advise you to switch the UV off.

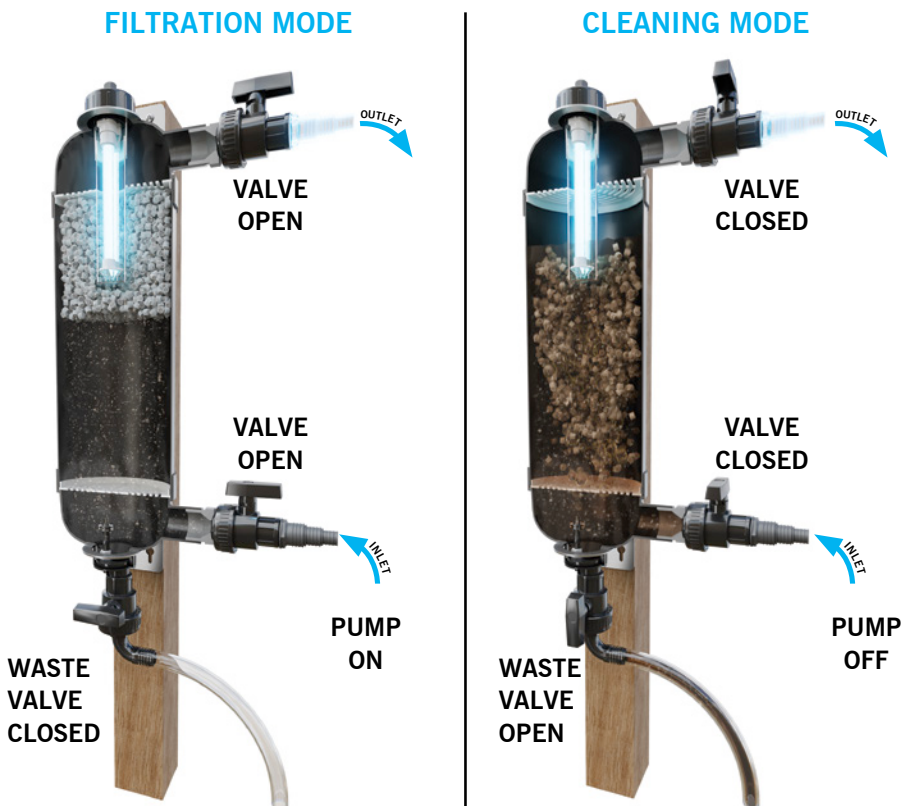

CLEANING THE SURGE FILTER

The Surge Filter should be cleaned regularly, at least once per month or as and when required. A cleaning process drops approximately 19 litres of water to waste. It is recommended to top up the pond with de-chlorinated water after each cleaning process.

TIP: Collect the waste water in a watering can and pour onto the soil to water your garden plants.



CLEANING STEPS

- STEP 1:** Close the ball valves on the inlet and outlet.
- STEP 2:** Switch pump off.
- STEP 3:** Open the tap on the waste valve assembly. Air enters the filter causing the filter media to move and clean as the water drains to waste.
- STEP 4:** Once the water has emptied from the filter, the media inside sinks to the bottom, close the tap on the waste valve assembly.
- STEP 5:** Turn the pump back on.
- STEP 6:** Open the ball valves on the inlet and outlet. Water will re-fill the tube, media will rise to the top, and water will return to the pond.
- STEP 7:** Repeat this procedure, if needed.

NOTE: The UVC can be left switched on during cleaning cycles. However, for prolonged periods of time when the filter is empty of water we advise you to switch the UVC off.

CLEANING THE SURGE FILTER

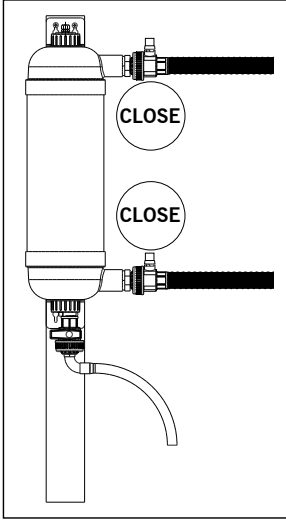

1. Close inlet and outlet ball valves

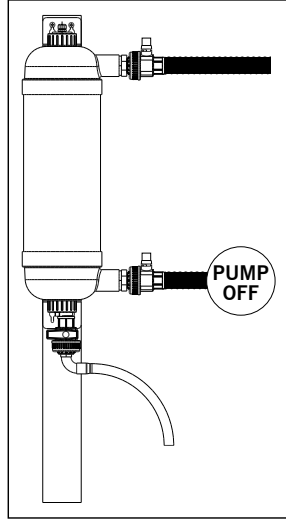

2. Switch pump off

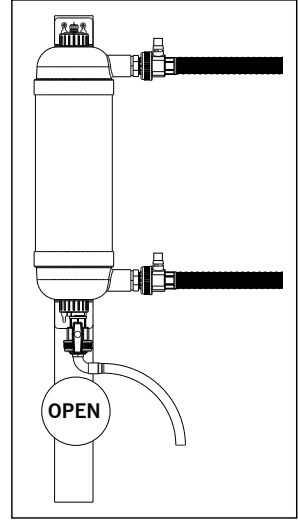

3. Open waste valve tap

Air enters the filter causing the filter media to move and clean as the water drains to waste.

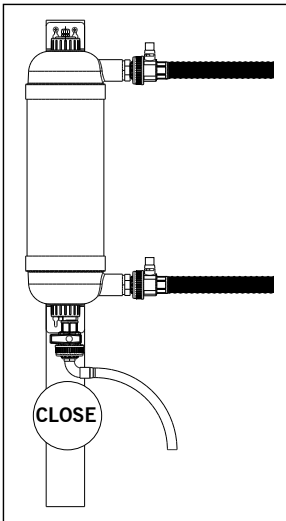

4. Close waste valve tap

All the water should have emptied from the filter and the media will be at the bottom.

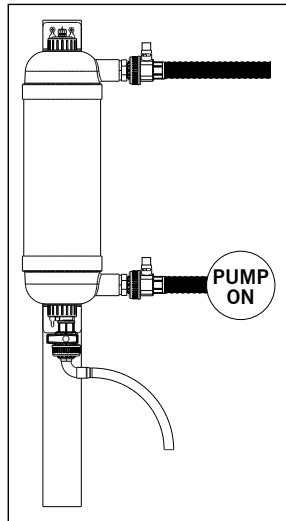

5. Switch pump on

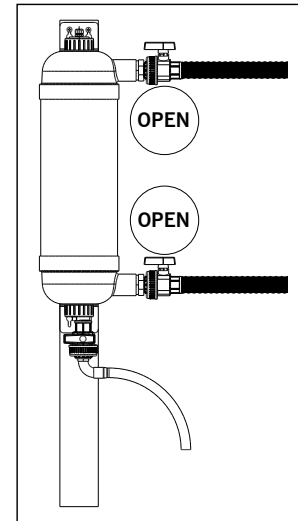

6. Open inlet and outlet ball valves

Water will re-fill the tube, media will rise to the top. and water returns to the pond.

TROUBLESHOOTING AND MAINTENANCE



LOOKING FOR MORE TROUBLESHOOTING ADVICE?

For troubleshooting, maintenance and frequently asked questions please scan the QR code to visit our website.

Checking the UV bulb is working

The UVC incorporates a safety switch interlock to avoid UV exposure. This means the UV bulb will only illuminate once the bulk head collar has been fully screwed onto the filter. You can safely check that the UV bulb is illuminated using the sight glass part of the clear hoesetail, but only when hose is connected. **WARNING: DO NOT LOOK DOWN THE END OF THE HOSETAIL DIRECTLY AT AN ILLUMINATED UV BULB.**

The UV bulb is not illuminating

- Check that the bulk head collar has been screwed onto the filter as far as it can go. If the mounting bracket has been positioned too high it may be preventing bulk head to be completely screwed in, which won't trigger the safety switch to light the bulb.
- Check the mains power supply is connected. Seek the advice of a qualified electrician.
- Inspect the ballast for any visible signs of damage, but do not unscrew the gland nuts.
- Check the 4 bulb pins are inserted in the lamp holder.
- Purchase and install new 18 PL-L UV-C bulb. AVAILABLE FROM EA STOCKISTS.
- If the bulb is still not illuminating, replace the ballast. AVAILABLE FROM EA SPARES WEBSITE OR EA STOCKISTS.

Waste water does not drain when the waste valve assembly ball valve is open

The inside of the black end cap at the bottom of the filter may be blocked. It is easy to clear this by switching off the pump and UVC and unscrewing the waste valve assembly, allowing you to inspect and clear the blockage.

Waste valve assembly is leaking

Turn off the pump and UVC and unscrew the waste valve assembly. Check the o-ring is seated correctly inside waste valve assembly. Inspect the waste valve assembly for any signs of damage or blockages, including the air inlet tube. If damaged, replacement parts can be purchased online at EA SPARES WEBSITE.

Removing the filter for maintenance

You will need to unscrew the UVC bulk head collar, remove the UV bulb, but leave the quartz sleeve in place. Loosen the screws on the top mounting bracket to slide the mounting bracket upwards without having to fully unscrew it. Also unscrew the waste valve assembly at the bottom of the filter. Then you can carefully lift the Surge Filter away and move it. **PLEASE NOTE:** if you also remove the quartz sleeve and then tilt the filter, it is possible for K+Media to escape out of the outlet. If K+Media does escape, re-fill it through the top gap and close the outlet valve and then re-fit the UVC.

CLEANING THE UV QUARTZ SLEEVE



WARNING: NEVER LOOK DIRECTLY AT AN ILLUMINATED UV BULB

It is good practice to clean the UV quartz sleeve as and when required.



Carry out steps 1 to 4 of the cleaning cycle to drain water out of the Surge Filter. The pump should remain off.

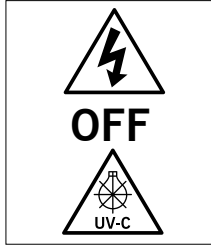

Turn off the power supply to the pump and the UVC.



Unscrew the UVC collar and carefully pull out the UV bulb unit. Do not touch the UV bulb. Store this safely.



Carefully ease out the quartz sleeve and slide it out of the filter. This may be tight.



Clean with a damp cloth, and dry it. If damaged, purchase a replacement sleeve from an EA stockist.



Check that the orange o-ring is still in place.



Check the black o-ring is in the groove of the quartz sleeve.



Re-fit the quartz sleeve.



Re-fit the bulb unit.



Tighten up the black collar.

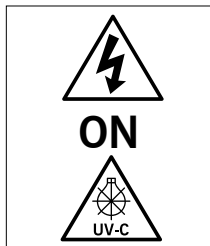

Turn the power supply to the UVC and pump back on.



Open the inlet and outlet valves to re-start the filter cycle.

REPLACING THE UV BULB



WARNING: NEVER LOOK DIRECTLY AT AN ILLUMINATED UV BULB

Replace the UV bulb when needed or once a year for optimum performance.



Carry out steps 1 to 4 of the cleaning cycle to drain water out of the Surge Filter. The pump should remain off.

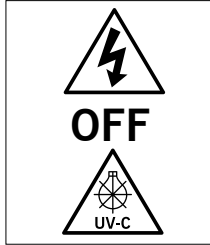

Turn off the power supply to the pump and the UVC.



Unscrew the UV collar and carefully pull out the UV bulb unit.



Hold the UV bulb with a dry cloth and carefully pull the plastic transit clip.



Carefully pull out the UV bulb from the 4 pin socket.



Replace the UV bulb with a new 18W PL-L UV bulb, available from EA stockists.



You do not need to re-fit the plastic transit clip, but its advisable to do this.



Check the black o-ring is in the groove of the quartz sleeve.



Slide the UV bulb back in.



Tighten up the black collar.

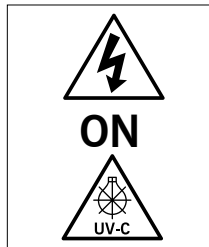

Turn the power supply to the UVC and pump back on.



Open the inlet and outlet valves to re-start the filter.

SPARE PARTS



SCAN QR CODE

To Access
EA Spares
Website

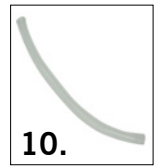
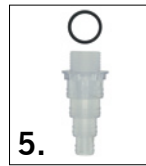
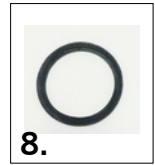
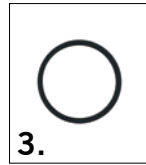
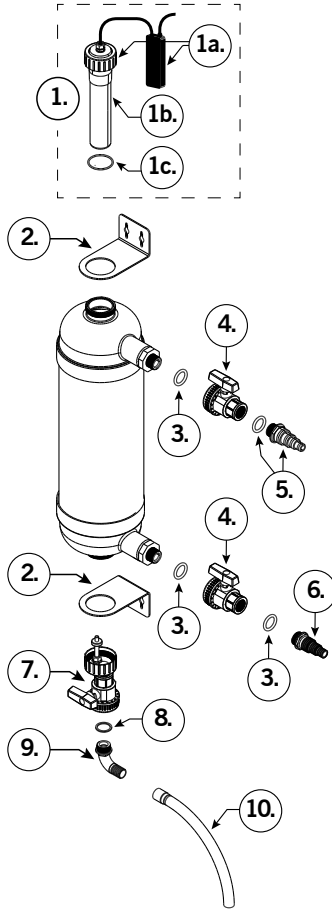

ITEM NO.	PART CODE	DESCRIPTION
1	CUV-118	COMPLETE 18 WATT UVC INC. BULB, QUARTZ, O-RING AND BALLAST
1a	CUV-118 BALLAST	18 WATT UVC BALLAST (NO BULB OR QUARTZ)
1b	CUV-118 QUARTZ SLEEVE	QUARTZ GLASS SLEEVE FOR CUV-118
1c	1000-957	CUV-118 O-RING
2	5300-005	STAINLESS STEEL MOUNTING BRACKET
3	1000-951	NITRILE O-RING
4	K25-51-32	BALL VALVE
5	HOSETAILCLEAR	CLEAR HOSETAIL AND O-RING FOR INLET
6	K22-90-23	BLACK HOSETAIL FOR OUTLET
7	SURGEWSA	SURGE WASTE VALVE ASSEMBLY
8	EVOUVFLATWASHER	FLAT WASHER FOR THREADED ELBOW
9	HOSETAILBLACK	THREADED ELBOW FOR WASTE ASSEMBLY
10	CLEARHOSE 25	50CM LENGTH OF CLEAR HOSE

GUARANTEE

This product is guaranteed against defects in material and workmanship for 2 years from the date of purchase, under normal usage. The guarantee DOES NOT APPLY in case of improper use, negligence, lack of maintenance or accidental damage to the Surge Filter.

If the Surge Filter fails due to a manufacturing fault within this period it will be either repaired or replaced free of charge. Liability is limited to replacement of the faulty product only; no other costs will be reimbursed. This guarantee is not transferable and does not affect your statutory rights. This guarantee does not confer any rights other than those expressly set out above.

The UVC ballast is also covered by a 2 year guarantee, excluding the UV bulb and quartz sleeve.

The manufacturer or supplier shall not be responsible, or held liable for any damages caused by defective components or materials of this product; or for loss incurred by interruption of service; or any consequential/incidental damages and expenses arising from the production, sale use or misuse of this product or any other consequential loss.

Any warranty claim must be accompanied by a valid, dated proof of purchase.

Evolution Aqua and its dealers shall not be held liable for any loss of fish, plants or any other livestock as a result of any failure or defect of this product.

The installation and use of your product outside of our recommendations as printed in this manual may also void the warranty.

REGISTER YOUR WARRANTY

Register your warranty by visiting our website and completing the online form.

Scan the QR code or visit www.evolutionaqua.com

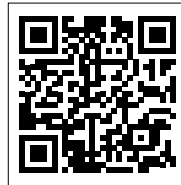

VISIT OUR WEBSITE AND FOLLOW US ON SOCIAL MEDIA



For all the latest Evolution Aqua news sign up to our email newsletter to have the newest info delivered direct to your inbox. Keep up to date by following us on social media, join our Pond Owners Club on Facebook or check out our website for technical information and product advice at www.evolutionaqua.com.



INSTRUCTION MANUALS

Download instruction manuals for all Evolution Aqua products



PARTS STORE

Find spare parts and accessories for Evolution Aqua products



FAQS

Read frequently asked questions about Evolution Aqua products



EMAIL NEWSLETTERS

Sign up to receive our email newsletters at evolutionaqua.com/newsletter



STOCKISTS

Locate your nearest Evolution Aqua product stockist



EA POND OWNERS CLUB

Search Evolution Aqua Pond Owners Club on Facebook to join the community



FACEBOOK

Keep updated with our latest news at facebook.com/evolutionaqua



INSTAGRAM

Follow us on Instagram for updates at instagram.com/evolution_aqua



TIKTOK

Follow us on TikTok at tiktok.com/@evolution_aqua



YOUTUBE

Watch our YouTube channel at youtube.com/evolutionaqualtd

Evolution Aqua Ltd

Kellet Close

Wigan

Lancashire

United Kingdom

WN5 0LP

www.evolutionaqua.com