

★ Allowance : $\pm 5\%$

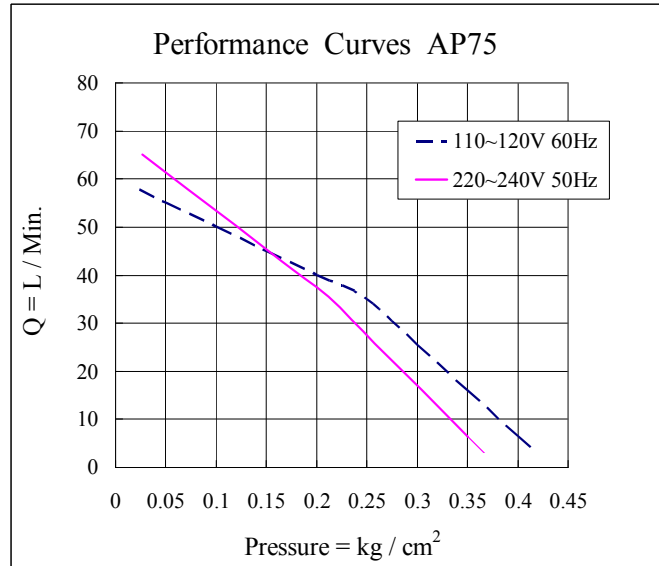

Exhaust

Dimensions (mm)

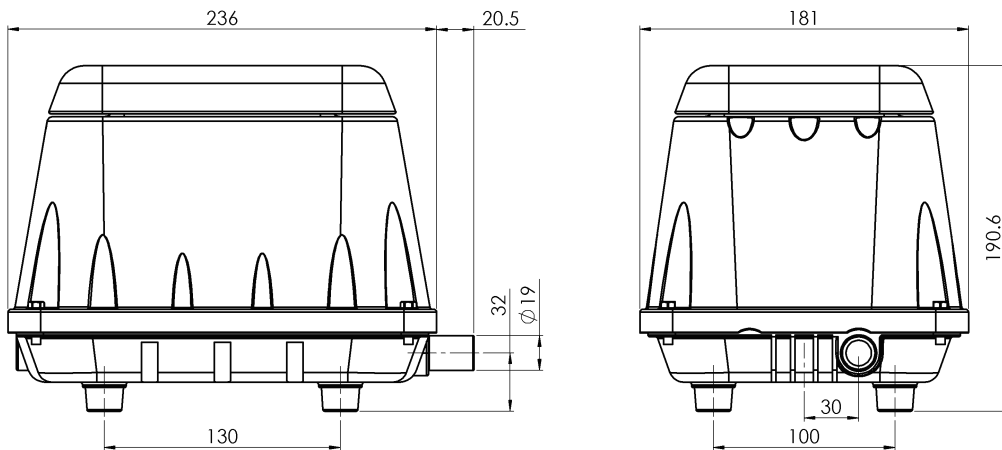

Operating range : 0.05 to 0.2 kg/cm²

Model No.	Voltage (VAC)	Frequency (HZ)	Rated Pressure (kg/cm ²)	Airflow (LPM)	AMP (A)	WATT (W)
AirPump 75	110 ~ 120	60	0.13	47	0.9	45
AirPump 75	220 ~ 240	50	0.13	50	0.46	43